

TABLE OF CONTENTS

INTRODUCTION.....	2
1. INSTRUMENT DESCRIPTION.....	3
2. INSTALLATION	5
A. Unpacking the BIO-SOLEA 2.....	5
B. Location	5
C. SET UP.....	5
3. BIO-SOLEA 2 USE	6
A. Starting	6
B. Turning the BIO-SOLEA 2 OFF	6
C. Inactivity period:	6
D. Preliminary operations.....	7
E. Conducting an Analysis.....	8
F. Reagent Use.....	9
G. Evaluation / Reference Curves.....	9
H. Quality Control.....	9
4. PARAMETERS	10
A. Setting up the Tests	10
B. Editing Calibration Values	10
C. Input of Rising or Falling Reference Curves	10
D. Setting up a PT - Test	11
E. Setting up a PTT - Test	12
F. Setting up a TT - Test.....	13
G. Setting up a FIB Test.....	14
H. Setting up Tests A, B, C and D	15
5. PRINTING OPERATIONS	16
A. Printer DPU 414 (optional)	16
B. Installing the DPU 414 Printer.....	16
C. Printer Logs	16
D. Printing the Test Parameters.....	17
6. TROUBLESHOOTING.....	18
A. Error Description	18
B. Error Messages	19
C. Operational check of the BIO-SOLEA 2.....	19
D. Maintenance	19
E. Cleaning	19
APPENDIX A: GENERAL SAFETY INFORMATION.....	20
APPENDIX B: WEEE AND ROHS DIRECTIVES	21
APPENDIX C: IMPORTANT NOTICE ABOUT BIOHAZARD.....	21
APPENDIX D: WARNINGS.....	22
APPENDIX E: TECHNICAL INFORMATION / ACCESSORIES.....	23

INTRODUCTION

BIO-SOLEA 2 coagulometers are up-to-date, processor controlled semiautomatic measuring instruments for in-vitro-diagnostic blood coagulation analysis. The patented opto-mechanical measuring system determines the clotting time of plasma by using the effect of a change in optical density when the clotting starts. The system monitors the reaction progress during the analysis and indicates critical results to the user. The integrated computer processes the measuring times. The results are given in several units, such as INR, % or mg/dl. The automatic checking of the BIO-SOLEA 2 eliminates the need for servicing and setting. Its compact design and simple handling make the BIO-SOLEA 2 a powerful coagulometer.

The following clotting analyses can be conducted with the BIO-SOLEA 2:

- | | |
|--------------------|---------------------------------------|
| 1. PT | Prothrombin time |
| 2. PTT / APTT | Activated partial thromboplastin time |
| 3. TT | Thrombin clotting time |
| 4. FIB | Fibrinogen |
| 5. Test A, B, C, D | Free tests for factor definitions |

Functions of the BIO-SOLEA 2

- Automatic start when reagent is added
- Entering Calibration Curves
- Entering of reagent-specific data, for example ISI
- Entering of test-specific incubation times
- Automatic start of the incubation timer when inserting cuvettes
- Calculation of probe activity
- Serial interface (RS 232) for connecting a printer or PC
- Reaction process monitoring
- Notification of critical events
- Automatic self-control

1. Instrument description

The measuring system

A circulating magnet underneath the stationary cuvette [1] causes a steel ball to rotate. This ball optimises the gentle mixing of plasma and reagent resulting in uniform coagulation. The ball binds the developing fibrin threads together - concentrating them in the optical light path. The start of coagulation within the sample is, therefore, synchronously achieved. This patented method assures reliable signal detection even with low fibrinogen concentrations. Optical monitoring of the sample is achieved through the use of an LED as transmitter and a photo-diode as receiver. This circuit is controlled and regulated by a processor. The sample is scanned by means of a pulse method which is completely immune to external light. The light source intensity is automatically adjusted to match the sample's turbidity, thereby assuring reliable measurement. A light guide additionally protects the sensors from becoming soiled.

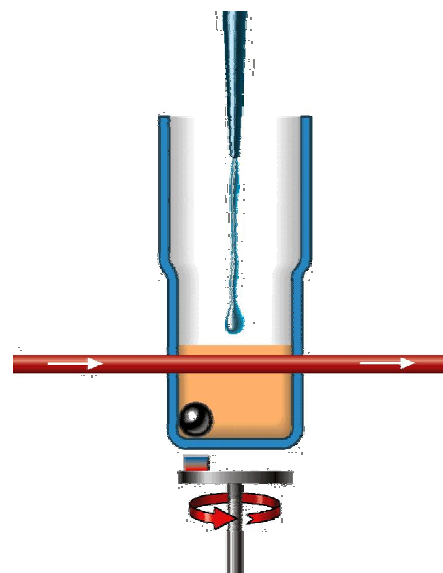

The Computer

All analogue signals such as the temperature or the measuring signal are digitalized and controlled, monitored and evaluated by the internal computer. This computer can be updated with new software through the interface.

The Incubation

The incubation time is activated by sample insertion thanks to the sensors located underneath the right-hand incubation position. A red LED [2] flashes ten seconds prior to the completion of the incubation time. The time is programmable according to the relevant test.

The key pad

All entries for programming and processing are entered with two keys [3].

The Evaluation

Measuring results can be displayed in %, INR, ratio, mg/dl, g/l and seconds.

The Display

The alpha-numerical display [4] provides the user with all essential information.

The Reagents incubation position

Various size of reagent containers [5] are available (furnished with the instrument). In order to reach the required temperature of 37°C, the volume of reagent must not exceed the top of the incubation well of the instrument.



Instrument Back side

1 RS 232 Interface <COM>
Connection to a printer or a PC.

2 Switch <POWER>
Switch the BIO-SOLEA 2 ON and OFF

3 Connector <AC/DC>
Connector for mains adapter.



2. INSTALLATION

A. UNPACKING THE BIO-SOLEA 2

Check the packaging for any signs of shipping damage.

Caution! If packaging or contents is damaged, put a claim in with the freight forwarder and notify BIOLABO or your local agent.

Open the packaging and remove the accessories and the instrument. Make sure the contents are complete.

The following items are standard accessories for the BIO-SOLEA 2:

- AC adapter
- Ball dispenser
- Cuvettes
- Cuvettes racks
- 500 Balls
- 50 Reagent containers
- Dust cover
- Operator's manual

Keep the original packaging for possible later transport.

Caution! Direct or indirect damage to the instrument caused by using improper packaging during shipment is not covered by BIOLABO's liability or warranty.

B. LOCATION

Place the instrument on a stable and vibration-free support. Avoid its placing near heat sources (e.g. heaters, ovens, under high power lamps), under direct sunlight, near strong electromagnetic sources (e.g. motors) or with the instrument's back close to a wall, which would block the cooling air flow. The operational temperature range is 17-28C° and humidity must be under 80%.

C. SET UP

Procedure to install the instrument. Please, in the case of any doubt or ambiguity in understanding this procedure, contact your nearest distributor since an improper installation may damage seriously the instrument.

The instrument works with 230 V AC \pm 10% / 50-60 Hz power supply.



WARNING: make sure the chosen supply socket has a suitable earth connection, since it is required to assure user's safety during instrument usage.

- Before connecting the instrument to the power supply, make sure that it is switched off. In this case, the switch on the polynap module in the backside of the instrument must be in the 0 position.
- Do not place near centrifuges, washers, dishwashers, etc.
- Do not connect other electrical appliances which may cause interference with the circuit.
- Do not set up the instrument near electrical appliances causing electric interference (appliances bearing no CE-label).
- Avoid connection to circuits where other appliances consume large amounts of current (for example centrifuges) or which turn on and off frequently (for example refrigerator, water bath, etc.).
- All connections to the instrument should be made with the instrument turned OFF.

3. **BIO-SOLEA 2 USE**

A. STARTING

- 1 Set the switch <POWER> at the rear of the BIO-SOLEA 2 to position "0".
- 2 Plug the cord of the AC adapter into the <AC/DC> socket.
- 3 Connect printer or host computer cable to the <COM> connector (Only if printer or host computer is available).
- 4 Check that all cords and cables are properly connected.
- 5 Plug the AC adapter into the mains socket outlet.
- 6 Turn on the BIO-SOLEA 2 with the <POWER> switch.

B. TURNING THE BIO-SOLEA 2 OFF

- 1 Turn off the BIO-SOLEA 2 with the <POWER> switch
- 2 Remove all cuvettes
- 3 Use a wet cloth to clean the instrument (see also § 6.E Cleaning p.19)
- 4 Cover the BIO-SOLEA 2 with the dust cover supplied

C. INACTIVITY PERIOD:

If the instrument has to be prepared for long inactivity time (more than one week), it is recommended to follow this procedure:

- Use a wet cloth to clean the instrument.
- Protect the instrument with the dust cover.
- Use always original package to pack/ship the instrument.
- Store the instrument between 10°C to 40 °C, avoiding moisture and wet place.



CAUTION: BIOLABO declines any responsibility in the event of misuse of the material or non-observance of the instructions indicated above.

D. PRELIMINARY OPERATIONS

Refilling the ball dispenser:

Unscrew the tip of the ball dispenser.

Pour the balls from their container into the hand-held portion of the ball dispenser.

The tip is then re-screwed.

Connecting printer or host computer (optional)

Turn ON the **BIO-SOLEA 2** with the <POWER> switch on the rear side of the instrument.

- The indicators of the two incubation channels briefly illuminate and a beep sounds.

- The following text is displayed:

"BIOLABO www.biolabo.fr BIO SOLEA 2 V1.14"

- The date entered last appears in the display
Press <TEST> to confirm the date

To change the date:

- Use the <RESET> key to choose the value to be changed.
- Change this value by pressing the <TEST> key as often as necessary
- Use the <RESET> key to choose the next value and change accordingly using the <TEST> button, or
- Press the <RESET> key to go to the remaining values. When the last value is reached, press <RESET> again to confirm the new date.
- The message "LOAD DATA" is displayed briefly.
- Until the working temperature is reached, the message "TEMP LO" flashes in both displays.
Note: At a room temperature of approx. 23°C, the warm-up time is approx. 10 - 15 minutes.
- As soon as the correct temperature has been reached, "ADJUST" flashes in both displays, followed by a display of the most recently measured test, e.g. "PT TEST double".

The **BIO-SOLEA 2** is now ready for operation.



CAUTION: It is assumed that your system has been properly adjusted to the requirements of your lab when working in the routine. This is described in the section "Editing the Calibration Values."

This description presupposes that the **BIO-SOLEA 2** is programmed as detailed in section "Editing the Calibration Values".

For information regarding measuring result evaluation or conversion, refer to the instructions provided by the technical data sheet of the used reagent.

E. CONDUCTING AN ANALYSIS

(Example of a PT - double determination)

- 1 Reconstitute the PT – reagent as described in the technical data sheet of the reagent being used.
- 2 Fill PT - reagent in the reagent bottle and heat up to 37°C in the reagent incubation position (5).
Note: In order to reach the required temperature of 37°C, the volume in the reagent bottle must not exceed the top of the incubation well (1 mL). The warm-up time required depends on the reagent temperature and may take 5 - 8 minutes.
- 3 With the <TEST> key, choose for example “PT Test double”.
- 4 Break the cuvette racks at the point of fracture and place the cuvettes in one of the two incubation rows.
- 5 Dispense one ball from the ball dispenser into each cuvette.
Note: The ball dispenser should be placed on the cuvette so that no ball can bounce back out of the cuvette.
- 6 Fill patient plasma, 100µl each, in the cuvettes.
- 7 By exerting brief pressure on the right-hand cuvette, the incubation timer is started. At the beginning of the incubation time a beep sounds and a red LED illuminates on the right of the cuvettes. 10 seconds before the end of the incubation time the LED starts flashing, a beep indicates that the incubation time has lapsed and the LED is turned off.
- 8 Set the cuvette in the measuring channel after the incubation time has lapsed and press <RESET>. “Adjust” flashes in the display. This means the measuring system adjusts itself to the turbidity of the probe. When “Adjust” disappears, measuring can be started.
Note: Exerting slight pressure, push the cuvettes all the way down to the stop in the measuring channel.
- 9 Draw up PT - Reagent (200µl) and pipette it into the cuvette.
- 10 Upon the occurrence of clotting the measuring time is stopped. When both measuring times are determined, the value in seconds is briefly displayed; afterwards the display automatically shows the adjusted value of the requested parameters, for example %-activity or INR. By pressing the <TEST> key, the individual second values and the sample number can be displayed again.
- 11 Remove cuvette from the measuring channel and start the next analysis starting with item 8.

F. REAGENT USE

The BIO-SOLEA 2 works with all commercially available reagents, control plasmas or calibration plasmas for in-vitro-diagnostic coagulation analysis (chronometric measurement).

All information necessary for reagent preparation and use is provided by the technical data sheet of the reagent being used. The same applies to the respective control plasmas or calibration plasmas.

Always follow this information.

In case multiple ways of conducting a test are described (e.g. for automated instruments), the instructions concerning manual performance of the test are decisive.

An exception is the incubation time information. The information about the incubation time for manual performance refers to the use of a water bath. The efficiency of this incubation method is higher and cannot be equalled by an incubation block.

A minimum incubation time of 120 seconds is, therefore, recommended.

G. EVALUATION / REFERENCE CURVES

Refer to the technical data sheet of the reagent being used to know detailed information regarding reference curve elaboration and the measuring results evaluation.

H. QUALITY CONTROL

Quality control is made by using control and calibration plasmas. Always follow the instruction of the technical data sheet of the controls and standards being used.

4. PARAMETERS

A. SETTING UP THE TESTS

Reference curve values and other parameters for the coagulation tests mentioned below can be entered and stored in the BIO-SOLEA 2.

- | | |
|----------------|--------------------|
| 1. PT | 4. FIB |
| 2. APTT or PTT | 5. Test A, B, C, D |
| 3. TT | |

Tests A, B, C, D are available to the user as so-called "free" tests, for example, parameters for factor testing can be stored here.

In this section, setting up the individual tests is described.

B. EDITING CALIBRATION VALUES

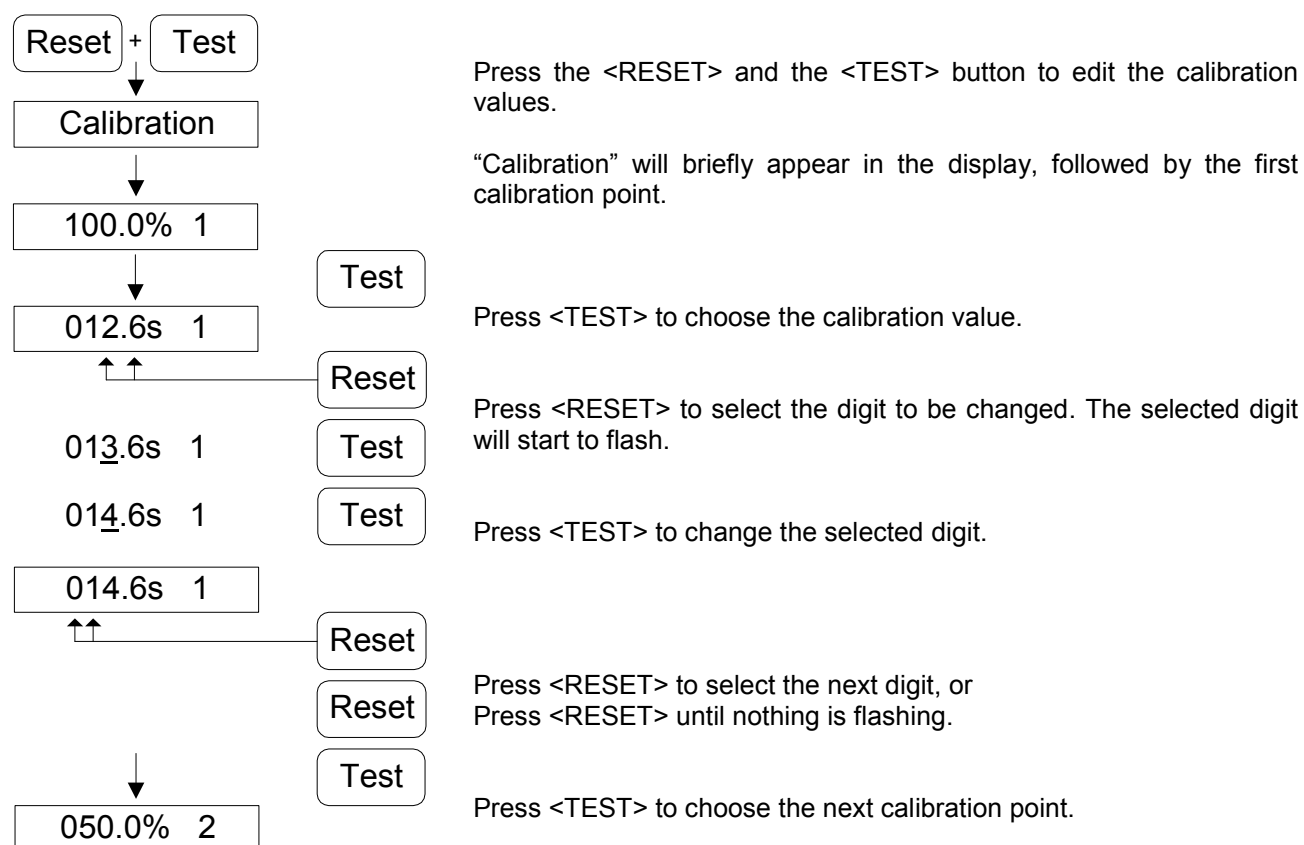

Note: The calibration points (% , mg/dl or g/l) are edited in the same way as described above.

C. INPUT OF RISING OR FALLING REFERENCE CURVES

When entering reference curves having a rising or falling course, the following must be observed.

The calibration value time data must always rise from the first to the last calibration point. Only the quantity information (% , mg/dl, g/l) may be rising or falling.

If a calibration time value smaller than the previously entered value is entered, this will be indicated by an alarm tone and the message "ERROR 20" in the display. By pressing <TEST>, the error message is cleared and the system returns to the first calibration point to correct the entries.

D. SETTING UP A PT - TEST

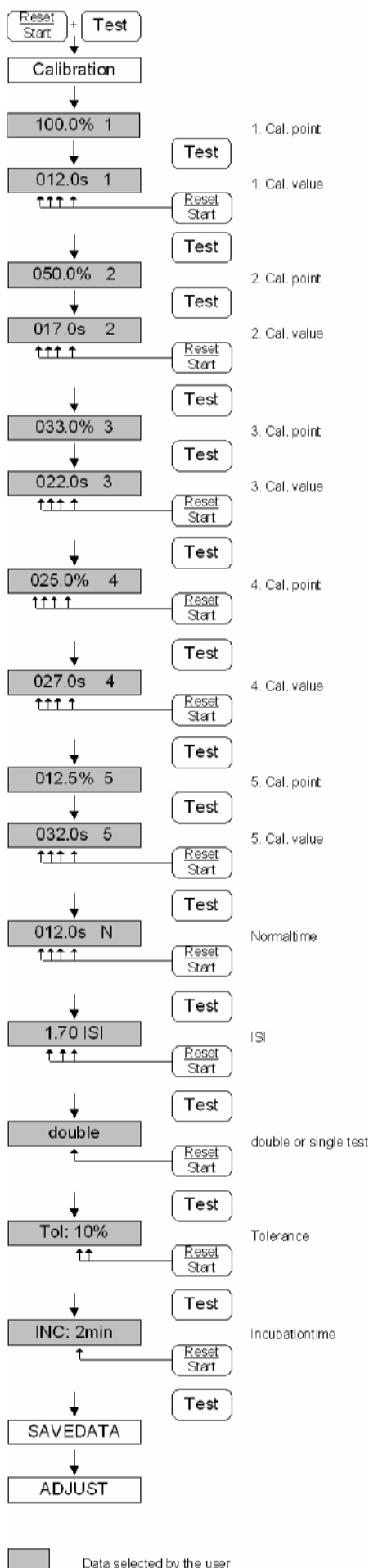

The BIO-SOLEA 2 is factory-set as follows:

Calibration curve: 100.0% - 000.0s

To obtain a measuring result in %

- a time value (calibration value) must be assigned for each calibration point.
- at least 2 calibration points must be entered.

Note: A maximum of 5 calibration points can be set. If, for example, only 4 points are to be set, enter the time value 000.0s for calibration point 5 (see example). It is also possible to add the calibration points (see example 4. calibration point).

To suppress adjustment in %, enter for the first calibration point (e.g. 100.0%) a calibration value of 000.0s.

Standard time: 12.0s

I.S.I.: 1.00

To obtain the measuring result in RATIO

- edit the standard time
- set the ISI value to 0.00

To obtain the measuring result in INR

- edit the standard time
- edit the ISI value

Note: The ISI value of the reagent is stated in the technical data sheet supplied with the reagent.

To suppress the adjustment in RATIO and INR, set the standard time to 000.0s.

Double / single determination: double

Select

- double = double determination
- single = single determination

Tolerance: 10%

Note: Only for "double" (repeat determination)

- edit the tolerance value of the single measurements

Note: If the tolerance is exceeded no mean value will be calculated. In this case each single value is separately adjusted and displayed

Incubation time: 2 min

Incubation time for samples

- select the corresponding incubation time

E. SETTING UP A PTT - TEST

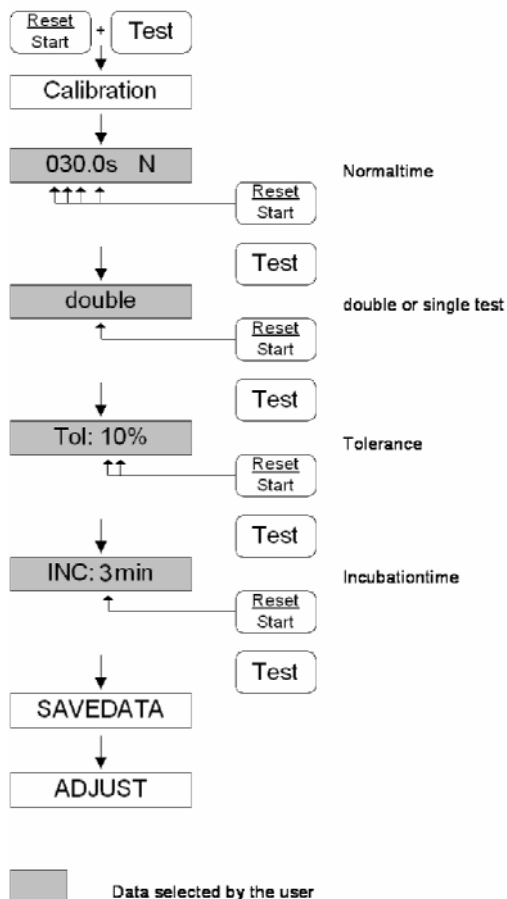

The BIO-SOLEA 2 is factory-set as follows:

Standard time: 0.0s

To obtain the measuring result in RATIO

- edit the standard time

To suppress the adjustment in RATIO, set the standard time to 000.0s.

Repeat / single determination: double

Select

- double = double determination
- single = single determination

Tolerance: 10%

Note: Only for "double" (double determination)

- edit the tolerance value of the single measurements

Note: If the tolerance is exceeded no mean value will be calculated. In this case each single value is separately adjusted and displayed

Incubation time: 3 min

Incubation time for samples

- select the corresponding incubation time

F. SETTING UP A TT - TEST

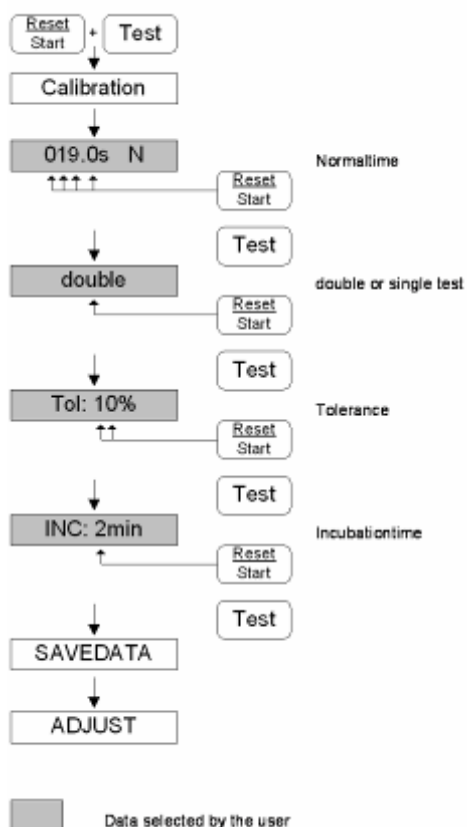

The BIO-SOLEA 2 2 is factory-set as follows:

Standard time: 0.0s

To obtain the measuring result in RATIO

- edit the standard time

To suppress the adjustment in RATIO, set the standard time to 000.0s.

Double / single determination: double

Select

- double = double determination
- single = single determination

Tolerance: 10%

Note: Only for "double" (double determination)

- edit the tolerance value of the single measurements
- Note:* If the tolerance is exceeded no mean value will be calculated.
In this case each single value is separately adjusted and displayed

Incubation time: 2 min

Incubation time for samples

- select the corresponding incubation time

G. SETTING UP A FIB TEST

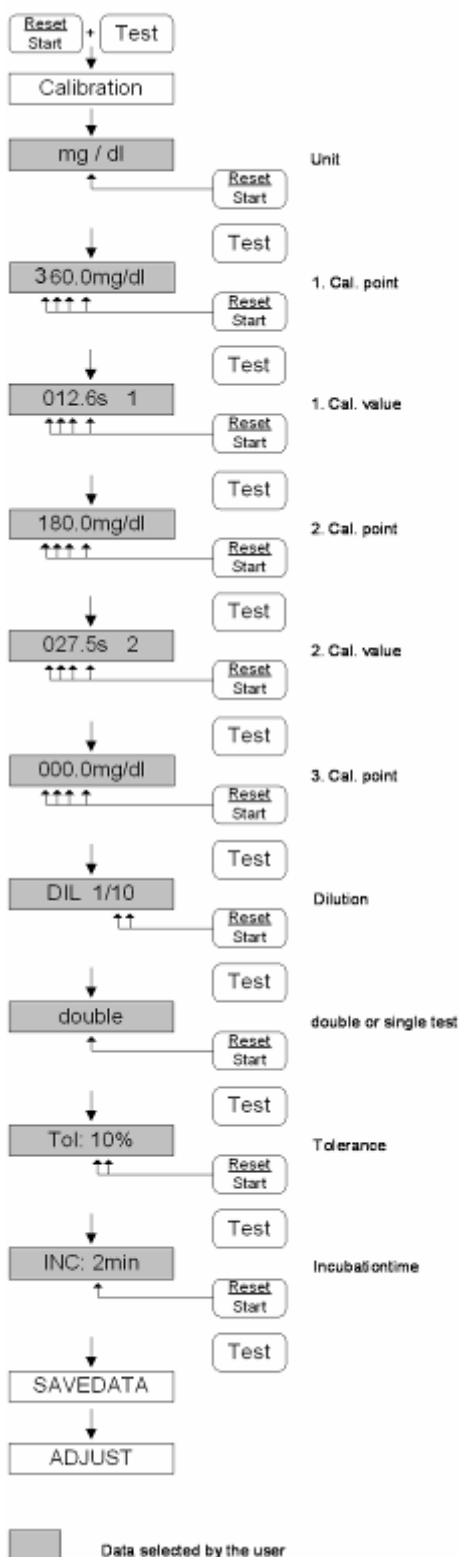

The BIO-SOLEA 2 is factory-set as follows:

Unit: mg/dl

Choose the unit (mg/dl or g/l) the concentration is to be indicated in.

Calibration curve: 360 mg/dl

To adjust the measuring result

- a time value (calibration value) must be assigned for each calibration point.
- at least 2 calibration points must be entered.

Note: A maximum of 5 calibration points can be set. If, for example, only 2 points are to be set, enter 0.000mg/dl for the third calibration point.

Dilution: 1/10

Enter the dilution factor used in sample preparation.

Note: The dilution factor is considered for the adjustment.

Double / single determination: double

Select

- double = double determination
- single = single determination

Tolerance: 10%

Note: Only for "double" (double determination)

- edit the tolerance value of the single measurements
- Note: If the tolerance is exceeded no mean value will be calculated. In this case each single value is separately adjusted and displayed*

Incubation time: 2 min

Incubation time for samples

- select the corresponding incubation time

H. SETTING UP TESTS A, B, C AND D

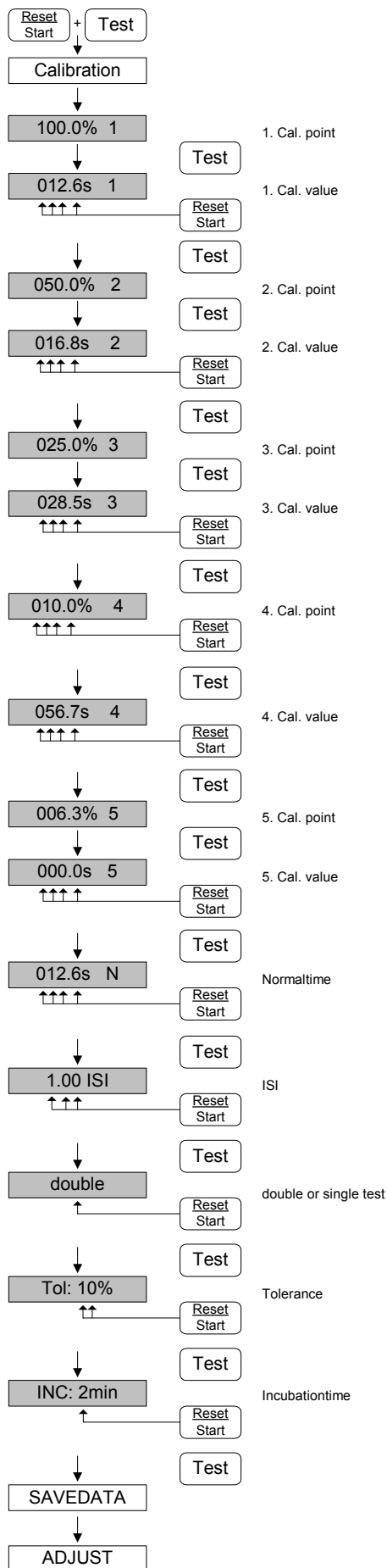

With tests A - D factor determinations and other coagulation tests can be set up.

The BIO-SOLEA 2 is factory-set as follows:

Calibration curve: 100.0% - 000.0s

To obtain a measuring result in %

- a time value (calibration value) must be assigned for each calibration point.
- at least 2 calibration points must be entered.
Note: A maximum of 5 calibration points can be set. If, for example, only 4 points are to be set, enter the time value 000.0s for calibration point 5 (see example). It is also possible to add the calibration points (see example for the fourth calibration point).

To suppress adjustment in %, enter for the first calibration point (e.g. 100.0%) a calibration value of 000.0s.

Caution! When entering calibration curves having a rising or falling course the following must be observed! The calibration value time data must always rise from the first to the last calibration point. Only the quantity information (% , mg/dl , g/l) may be rising or falling.

Standard time: 12.0s
I.S.I.: 1.00

To obtain the measuring result in RATIO

- edit the standard time
- set the ISI value to 0.00

To obtain the measuring result in INR

- edit the standard time
- edit the ISI value

Note: The ISI value of the reagent is stated in the technical data sheet supplied with the reagent.

To suppress the adjustment in RATIO and INR, set the standard time to 000.0s.

Double / single determination: double

Select

- double = double determination
- single = single determination

Tolerance: 10%

Note: Only for "double" (double determination)

- edit the tolerance value of the single measurements
Note: If the tolerance is exceeded no mean value will be calculated. In this case each single value is separately adjusted and displayed.

Incubation time: 2 min

Incubation time for samples

- select the corresponding incubation time

5. PRINTING OPERATIONS

A. PRINTER DPU 414 (OPTIONAL)

The printer can be connected to the <COM> port of the BIO-SOLEA 2 with a serial input port. We offer a suitable printer as an optional accessory (DPU 414, Cat. No. 012 224).

The BIO-SOLEA 2 communication parameters are pre-set to:

Baud rate: 19200 Format: 8 Bit Parity: No Stopbit: 1

B. INSTALLING THE DPU 414 PRINTER

For instructions regarding installation and operation of the printer, refer to the instructions for use supplied with the printer. Turn both printer and BIO-SOLEA 2 off. The printer cable supplied is connected to the <COM> port of the BIO-SOLEA 2 and to the port marked "SERIAL" of the printer.

First switch the printer on, then the BIO-SOLEA 2.

C. PRINTER LOGS

```
BIOLABO S.A. www.biolabo.fr
BIO SOLEA - v1.14
```

```

** Test arrangement 1 **
Date                26/11/07
Channel Pat Test
1+2      A      PT double
-----
```

After switching the BIO-SOLEA 2 ON, the BIOLABO header, the instrument's designation and the program version are printed.

When the date is confirmed or corrected, the current date and the last selected test are printed. In this example PT - repeat determination.

```

Date                26/11/07
Result              1
Channel 1+2 PT
Time 1             14.6s
Time 2             14.8s
Average            14.7s
Activity            54.9%
INR                 1.18
```

The illustration on the left shows the log of a PT repeat determination.

```

Date                26/11/07
Result              1
Channel 1+2 PT
Time 1             14.6s
Time 2             13.8s?
Average            14.2s
Activity            54.9%
INR                 1.18
```

If the measuring is not unambiguous, the respective measuring time (in this case Time 2) is flagged with a question mark.

```

TOLERANCE OUT OF RANGE!
Date                26/11/07
Result              6
Channel 1 PT
Time 1             19.1s
Activity            40.7%
INR                 1.59

Result              6
Channel 2 PT
Time 2             15.3s
Activity            49.1%
```

If the single time values are out of tolerance no mean value will be calculated. In this case the single time values are treated like single determinations.

BIOLABO S.A. www.biolabo.fr
BIO-SOLEA 2 V1.14

```

** Test arrangement 1 **
Date          26/11/07
Channel  Pat  Test
1           A   PT single
2           B   PT single
-----

```

These two illustrations show the output after the BIO-SOLEA 2 is turned on and the date has been confirmed or updated, respectively, plus the log of the individual measuring results. The most recently run test was a PT - Test in single determination.

```

Date          26/11/07
Result                10
Channel 1   PT
Time 1      10.4s
Activity                93.5%
INR                0.87
-----

```

```

Date          01/07/02
Result                11
Channel 2   PT
Time 2      10.8s
Activity                87.6%
INR                0.90

```

D. PRINTING THE TEST PARAMETERS

```

** PT-PARAMETERSET **
Date          26/11/07
Point  Activity  Time
1       100.0%  12.0s
2        50.0%  17.0s
3        33.3%  22.0s
4         25.0%  27.0s
Normal time   : 12.0s
ISI           : 1.70
Tolerance     : 10%
Determination : double
Incubation time : 2min

```

Once all test parameters have been edited, the message "SAVEDATA" is displayed and they are stored in the BIO-SOLEA 2 and simultaneously printed out.

Would you like to print existing test parameters, select the respective test and proceed as detailed in section "Editing the Calibration Values". Confirm all items with the <TEST> button until the message "SAVEDATA" appears in the display.

6. TROUBLESHOOTING

A. ERROR DESCRIPTION

Symptom	Likely Cause	Explanation / Remedy
Early stop or poor consistency	Pipetting too forcefully. Sample preparation. Volume error.	Bubbles can form which disturb the ball movement and the measurement. Check the preparation of the sample. Check the volume.
Message "UNSTABLE"	Very large particles in the probe. The cuvette is not correctly placed in the measuring channel.	After measuring starts, the system could not detect a usable signal. Check plasma and reagent for large particles. Check position of the cuvette in the measuring channel. Repeat the test.
Message "NO CLOT"	Measurement was interrupted.	Measurement was stopped with <RESET>. Remove the cuvette from the measuring channel and press <RESET>.
Message "TIME OUT"	Dilution of sample Volume error	The maximum measuring time 599s was exceeded. The system did not recognise clotting. In this case the dilution of the sample should be checked. In case of Fibrinogen, plasma which has been over-diluted could be the cause.
Message "TOO DARK"	The measuring channel is dirty. A used cuvette might block the channel.	The respective channel sensor does not receive enough light/input. Message can occur when <RESET> was pressed. Clean the measuring channel with clean, slightly moist paper towel or cloth.
Message "TEMP HI"	The temperature of the measuring block is too high	One reason may be exposure to direct sunlight or installation close to a heater/radiator, which provides additional heating of the measuring block. In this case, the location should be changed. Another reason could be the room temperature is too high (> 30°C).
Message "TEMP LO"	The temperature of the measuring block is too low	The instrument is exposed to a cold draught or placed near an opened window. The instrument should be relocated.
The display remains dark	Instrument not turned ON. The AC adapter is not connected.	Check the following: "Power" switch at the rear of the instrument turned ON? Is the power cord from the AC adapter properly plugged into the "AC/DC" socket at the rear of the instrument? Is the AC adapter plugged into a mains socket outlet? Is the mains socket outlet ok? CAUTION! The outlet has to be checked by a qualified electrician! If all of the above is found to be in order, then contact customer service.
Printer does not print	Printer not online. Printer out of paper. Incorrect parameter setting at the printer.	Set the printer online. Install a fresh roll of paper. Check installation and parameter settings of the printer (see instructions for use).

B. ERROR MESSAGES

The following error messages may occur when the BIO-SOLEA 2 is turned ON or configured. The message is displayed in the display as "ERROR xx". The table below explains the meaning of the error messages.

Message	Meaning	Remedy
"ERROR 00"	Software error	Turn instrument OFF, then ON again
"ERROR 01"	Software error	Turn instrument OFF, then ON again
"ERROR 10"	Print buffer overflow	Turn instrument OFF, then ON again
"ERROR 20"	Calibration curve not constant	Correct calibration values (Enter measuring times in ascending order)
"ERROR 21"	Checksum error	Check test data entries
"ERROR 30"	Unknown transmission format	Update EPROM version * (devices are not compatible)
"ERROR 31"	Data transmission error	Update EPROM version * (devices are not compatible)

* These messages may appear when the software is updated. A software update is carried out by your customer service.

C. OPERATIONAL CHECK OF THE BIO-SOLEA 2

- Place a ball into each cuvette and fill it with a minimum of 250µl of distilled water or buffer. Place the cuvette into the measuring channel and press <RESET>.
- Start the measurement by tipping the top of a pipette (100µl) shortly in the cuvette. Both displays start measuring the time. The balls must move at the edge of the cuvette bottom.
- Stop the measuring after approx. 10 seconds in the same manner as measurement was started. The displays show the "results" and the respective activities. The balls are stopped.

To check the measuring time, you can use a stop watch parallel to the start and stop.

D. MAINTENANCE

The BIO-SOLEA 2 does not require periodic maintenance or adjusting. The instrument is maintenance-free. The instrument's software constantly monitors all functions. Changes in the system (for example ageing of the sensor) are automatically compensated.

E. CLEANING

To clean the BIO-SOLEA 2, use a paper towel moistened with an alcoholic solution or wiping disinfectant with a pH value between 7.4 and 9.0.

Any other detergents having a lower or higher pH value may cause damage to the casing, measuring block or other components.

CAUTION! DO NOT USE CLEANERS CONTAINING BLEACH OR CHLORINE: THEIR PH VALUE IS NORMALLY HIGHER THAN 9.0!

APPENDIX A: GENERAL SAFETY INFORMATION

IMPORTANT! This instrument shall only be operated by trained specialists, who have been instructed and trained in procedures using in-vitro-diagnostic. They must be familiar with the Instructions for Use and be able to work accordingly in order to fully utilise the capabilities of the BIO-SOLEA 2.

IMPORTANT! This product is an in vitro diagnostic medical device. It complies with the requirements of the directive 98/79/CE and the standards mentioned in the certificate supplied with it. These requirements and limits are designed to provide adequate protection against unwanted interference in home, office and industrial environments. This product generates and uses high-frequency energy and may radiate such energy if the product is not installed and operated as detailed in these instructions. We recommend that you observe the different warnings on the instrument itself and mentioned in the documentation supplied.



Caution! Follow all warnings and notes affixed to the instrument or mentioned in the instructions.

Intervention in and modification of the product, not explicitly approved by the equipment manufacturer, may result in a loss of functionality. The costs for necessary repairs are to be borne by the user.

The equipment manufacturer is not liable for any damage resulting from disregard of the specifications stated in these instructions, damage caused by handling of reagents and biological fluids or other action with the product not in conformity with these instructions.

Data processing equipment connected to the instrument, such as personal computers or printers, must conform to the EN 60950 or UL 1950 standard, respectively.

APPENDIX B: WEEE and ROHS DIRECTIVES

BIOLABO complies with WEEE EC Directive (2002/96/CE) about recycling of electrical and electronic equipment waste.

This EC Directive forbids collecting no more used electrical and electronic equipment waste with normal rubbish and entrust the producers the collection and the recycling of such kind of waste.

When you have to dismiss a BIOLABO instrument, please don't throw it with normal rubbish, but contact BIOLABO or the authorized dealer.

Wasting should be performed in the country were the instrument has been sold.

The label present on each instrument certifies that BIOLABO complies with WEEE Directive:



BIOLABO also assures that no one of the materials listed by ROHS Directive (2002/95/05) is used to build and assemble its instruments.

APPENDIX C: important notice about biohazard



Working with analytical instruments for in-vitro diagnostics involves the handling of human samples and controls, which should be considered at least potentially infectious. Therefore, every part and accessory of the instrument which may have come into contact with such samples must also be considered as potentially infectious.

Wear gloves when handling blood, blood samples and objects contaminated by blood!

Strictly follow the existing regulations pertaining to the handling and manipulation of reagents for laboratory use and blood samples!

Before servicing the instrument it is very important to thoroughly disinfect all possibly contaminated parts. Before the instrument is removed from the laboratory for disposal or servicing, it must be decontaminated. Decontamination should be performed by a well-trained, authorized person, observing all necessary safety precautions.











Instruments to be returned must be accompanied by a decontamination certificate completed by the responsible laboratory manager. If a decontamination certificate is not supplied, the returning laboratory will be responsible for charges resulting from non-acceptance of the instrument by the servicing centre or from any authority's intervention.

APPENDIX D: Warnings

Meaning of the warnings used in these instructions.

DANGER! This information is for your own safety.

CAUTION! Information for optimal BIO-SOLEA 2 use.

Graphic Symbols	
Symbol	Explanation
	Direct current (DC) IEC 417
	Alternating current (AC) IEC 417
	Direct or alternating current IEC 417
	Ground terminal IEC 417
	ON (mains switch) IEC 417
	OFF (mains switch) IEC 417
	Warning of a danger area (Caution, observe documentation) Black symbol on yellow background, ISO 3864
	Warning of a biological hazard Black symbol on yellow background, 90/379/EEC
	complies with the European directive: 98/79 EC
	complies with WEEE EC Directive (2002/96/CE) about recycling of electrical and electronic equipment waste
	Manufacturer
IVD	In Vitro Diagnostic

APPENDIX E: Technical Information / Accessories**Specifications**

	BIO-SOLEA 2
Protection class	I
Working voltage	12 - 24VDC or 10 / 20VAC
Power input	20W
	AC adapter
Protection class	II
Working voltage	230V AC \pm 10% / 50 - 60 Hz
Power consumption	20VA

Dimensions

	BIO-SOLEA 2	BIO-SOLEA 2 with packaging
L x W x H	30.5cm x 12.5cm x 11.0cm	40cm x 30cm x 18cm
Weight	2.2kg	3.1kg
	Space required	
L x W x H	40cm x 50cm x 50cm	

Ambient Conditions

Operating temperature	+17°C - +28°C
Storage temperature	+10°C - +40°C
Rel. Humidity	80% at 31°C - 50% at 40°C
Maximum heat output	20W
Overvoltage class according to Annex J, EN 61010-1:1993	II
Usage environment	Indoor use in residential areas, commercial dwellings and light industrial environments

Sample Volume

	(plasma + reagent)
Minimum	300 μ l
Maximum	400 μ l

Accessories

	Catalogue number
Cuvette racks + balls (800 tests)	CUB1800
Kyoline / Kyosha Printer+cable+2 Thermo Paper Rolls	DPU 414
Thermo Paper 110 mm (5 rolls)	DPUROLLS